

INSTALLATION MANUAL

MONTAGEANLEITUNG
INSTRUCTIONS DE MONTAGE
ISTRUZIONI PER IL MONTAGGIO

**KNOW
HOW
INSTALLED**

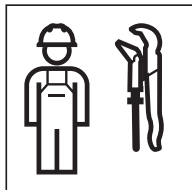



- Bu ürün TS EN 200'e göre üretilmiştir.
- This product is produced according to TS EN 200.

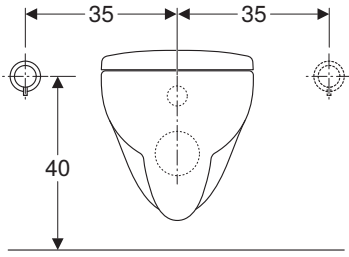

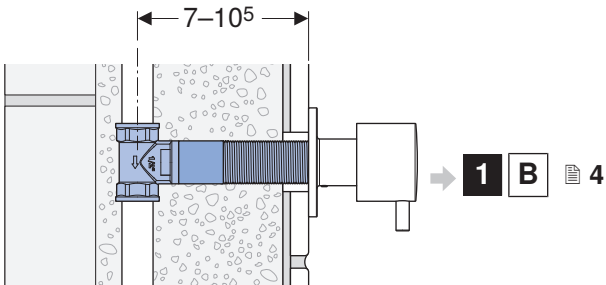
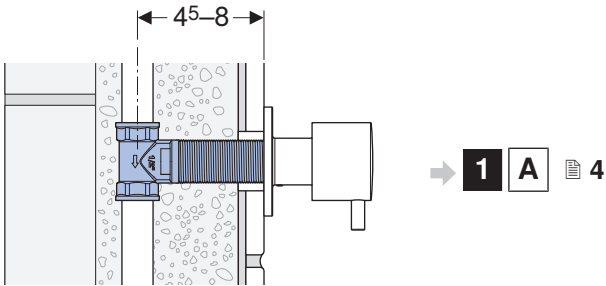

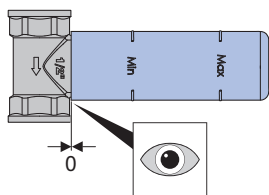
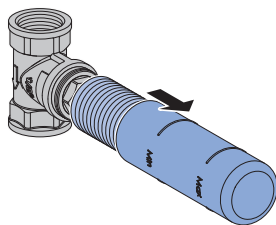
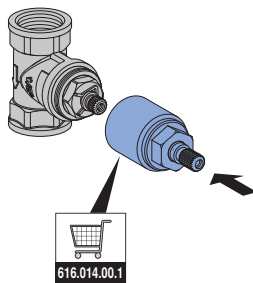
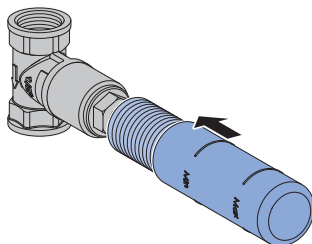
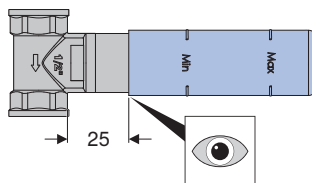
A**B****1****2****3****4**



1

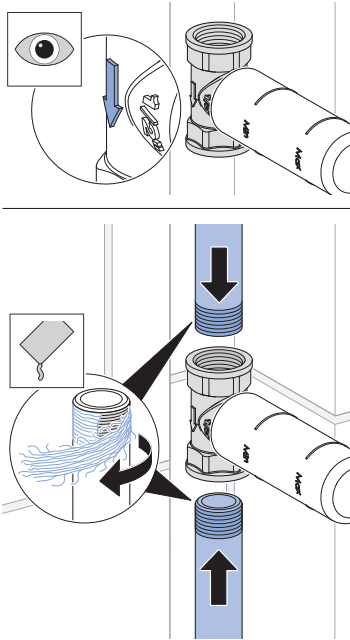

2

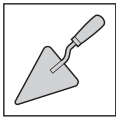

1

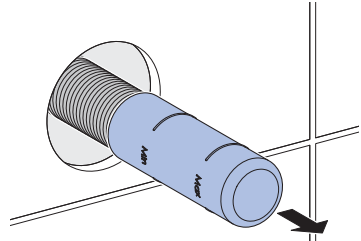

2

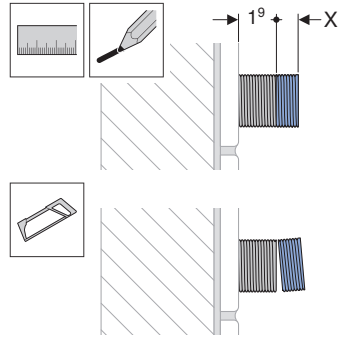

3

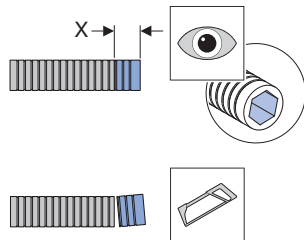

4

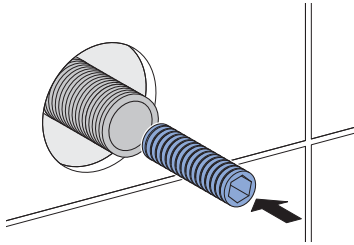

5

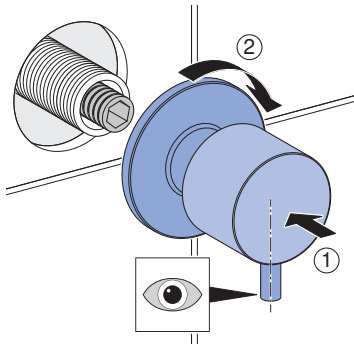

6

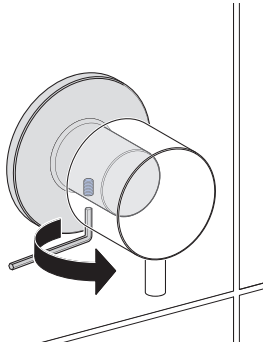

Geberit International AG
Schachenstrasse 77, CH-8645 Jona
documentation@geberit.com
www.geberit.com

